

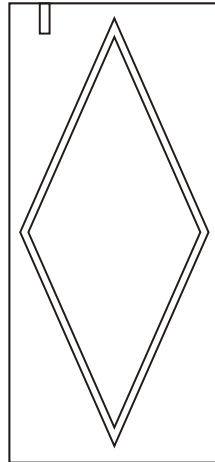

S5/S6-Bluetooth (For Android)

Bluetooth Standalone Access Control



S5-BT

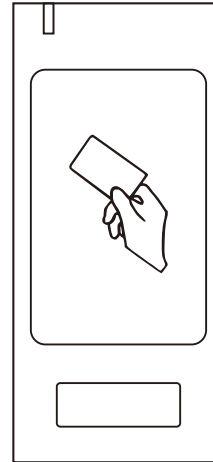

S6-BT



Introduction

The S5/S6-Bluetooth is a metal case anti-vandal standalone access control that can be mounted both indoor and outdoor. The unique feature is it can be operated by mobile phone through Bluetooth or Card. The operation is very smart and convenient.

Two versions optional:

- IC version: Read 13.56MHz Mifare card
 - ID version: Read 125 KHz EM card
- (Please use the appropriate card according to your device version)

Features:

- Vandal resistance enclosure
- Waterproof, conform to IP66
- One programming relay output
- 10,000 users (including card and mobile phone user)
- Two ways to open the door: Card, Mobile phone.
- Support opening the door through Bluetooth (version: 4.0 above), APP supports Android 4.3 above
- Support sending Remote E-key to others: (the Administrator can control access time)
- Latch mode to hold door or gate open
- Multi-color LED status display

Specification:

User Capacity Mobile Card (Version 1) Card (Version2)	10,000 Android 4.3 above 13.56MHz Mifare Card 125KHz EM Card <i>(Please choose the version before order)</i>
Operating Voltage Idle Current Active Current	12V DC ≤35mA ≤90mA
Proximity Card Reader Radio Technology Card Read range	Mifare Card / EM Card 13.56MHz / 125KHz 2~6cm

Bluetooth Range Reaction	Bluetooth Version:4.0 above <20m (relate to environment) <2seconds
Relay Lock Output Load	One(NO, NC, COM) 2 Amp Maximum
Environment Operating Temperature Operating Humidity	Meets IP66 -20°C ~ +60°C 0% ~ 98%
Physical Dimension Net Weight Shipment Weight	Zinc-Alloy Enclosure L103 X W48 X H19 (mm) 260g 300g

Carton Inventory

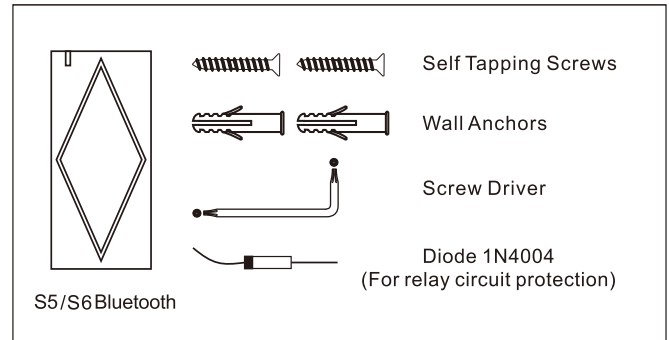

Installation

- Drill 2 holes(A,C) on the wall for the screws and one hole for the cable. thread the cable through the cable hole(B)
- Knock the rubber bungs to the screw holes(A,C). fix the back cover firmly on the wall with 4 flat head screws
- Attach the unit to the back cover.

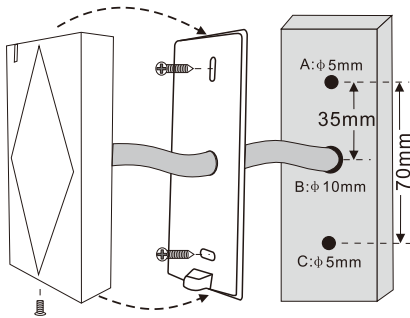

Wiring

No.	Color	Function	Notes
1	Green	NC	Normally Closed Relay Output
2	Brown	COM	Common Connection for Relay Output
3	White	NO	Normally Open Relay Output
4	Black	GND	Negative Pole
5	Red	+12V	Regulated Power Input
6	Yellow	OPEN	Request to Exit Input(REX)

Connection Diagram:

Common Power Supply:

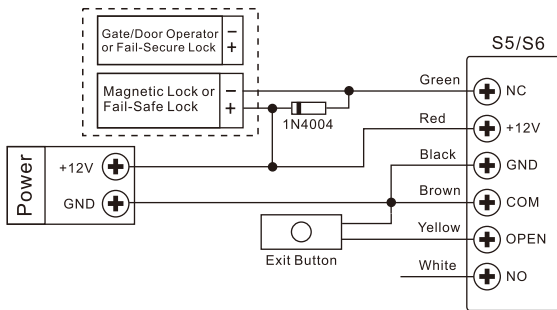

Attention: Install a 1N4004 or equivalent diode is needed when use a common power supply, or the reader might be damaged. (1N4004 is included in the packing)

Access Control Power Supply:

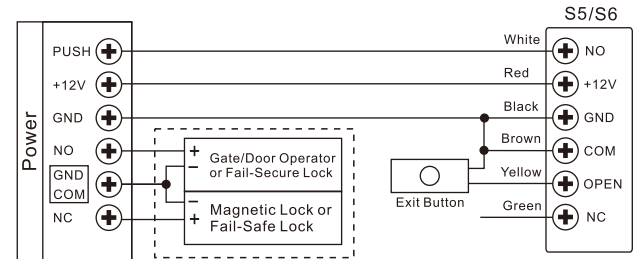

APP Operation

Here are just a few steps to get you started:

- 1) Make sure your Phone connects to the network, and the Bluetooth is turn on
- 2) Free download App



(Searching doormaster)

1. Register

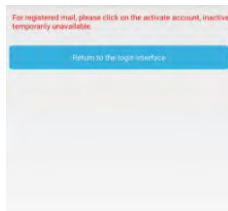
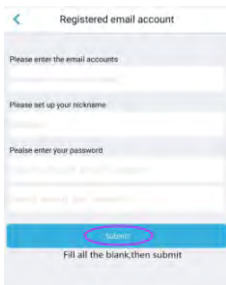

You will get an email from DoorMaster

Thank you for registering DoorMaster, please verify Email
DoorMaster [admin@intelligoo.com]
附件: sales@sa-access.com

Hi Jason,

Thank you for registering DoorMaster, please click on the following link to verify your Email.

<https://www.doormaster.me/9099/account/verifyemail?code=F8D523ACCA92D894FAA0046DD68759CD>
(If you can not click on the URL link address, copy it and paste it into your browser's address input box, and then click Enter. The link failure immediately after use.)

Note: Please use the message is received within one hour, otherwise the link will be deactivated.

DoorMaster

Click the Link to Finish Register

Then Register Successfully.

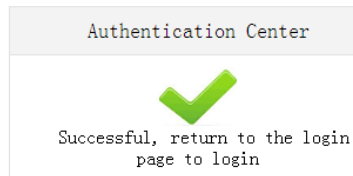

2. Add Device & Set Super Master

(Each device has one Super Master, the Super Master can send E-Key to other users so they have permission to open the door)

- Login the App with your email address and password

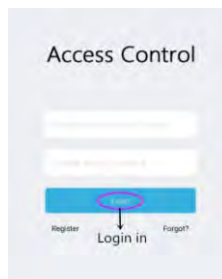

- Slowly press exit button for three times, when Red light flash, operate like below: (Remark: If the Red light doesn't flash, it means the Super Master has been added, please erase all users firstly-refer to page 16)

Slowly press exit button for 3 times (1 time/1s)

LED flash

Click Add Device on Mobile

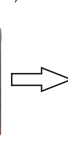

If it doesn't shine, it means the Super Master has been added, please erase all users firstly-refer to page 16

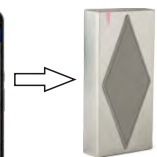



When hear one beep, means add device successfully.

When hear one “Beep”, means add device successfully.

3. Add Master Users & Common Users

Register an account, and then ask the Super Master send E-Key. The Super Master can decide the user to be Master User or Common User, their authorities are different (See below)

Authority	 Super Master User	 Master Users	 Common Users
Open Door	✓	✓	✓
Change Device Name	✓	✓	X
Add Card	✓	✓	X
Delete Card	✓	✓	X
Send E-Key	✓	✓	X
Set Relay Configuration	✓	X	X
Set Common Users as Master User	✓	X	X

Press the key next to device name to enter configure setting menu (Visitor Authorization and Synchronization Time settings are not available for the moment).

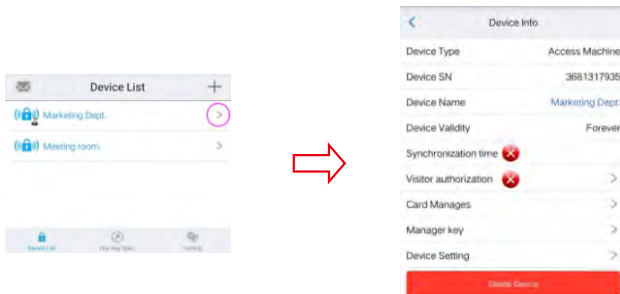

4. Add and Delete Card Users by App

Add Card Users by Reading Cards

When hear one “Beep”, the Red Led shines once per second, then read card on S5/S6 (Cards can be added continuously), after one beep, it means the card is added successfully, press “Exist swipe model” to back to menu.

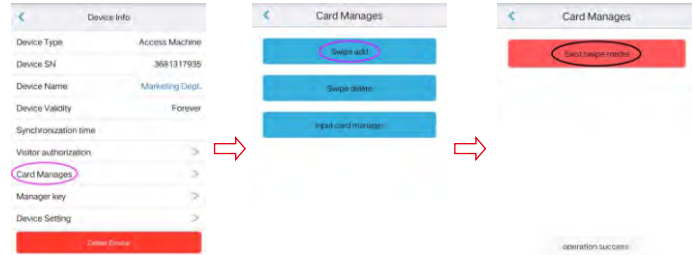

Delete Card Users by Reading Cards

When hear one “Beep”, the Red Led shines once per second, then read card on S5/S6 (Cards can be added continuously), after one beep, it means the card is added successfully, press “Exist swipe model” to back to menu.



Add/Delete Card Users by Card Number

Input 8/10 digits Card number in blank, then click Add the card or Delete the card

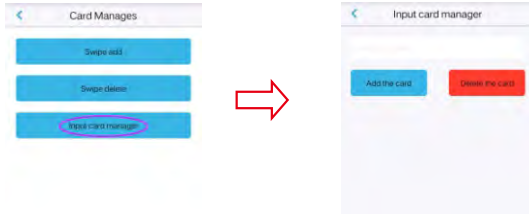

5. Set Relay Configuration

Lock Control: Set the door open time (Factory Default: 5 seconds)

Manually Control: Set the relay to ON/OFF mode (Latch mode)

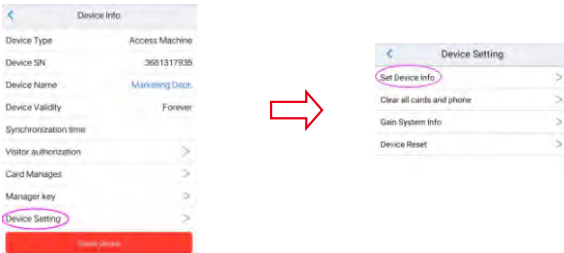

Lock Control Mode

OR

Manually Control Mode
(Latch Mode)



6. Open Door

1) Read the valid user card

2) Open the door by App: login in the App, and touch the device to open the door



3) "One Key Open"



4) "Shake Open" (Remark: This function is valid only after login in App) (Factory default is OFF)

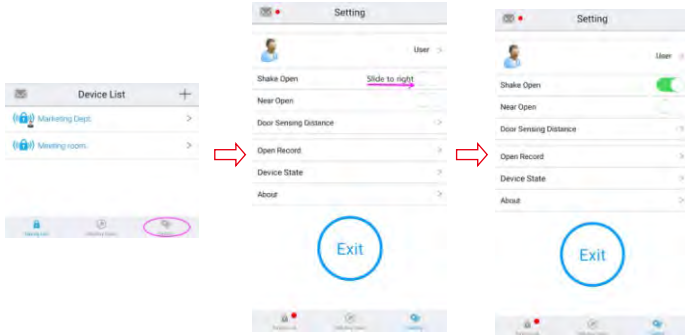

5) "Near Open" (Factory default is OFF)

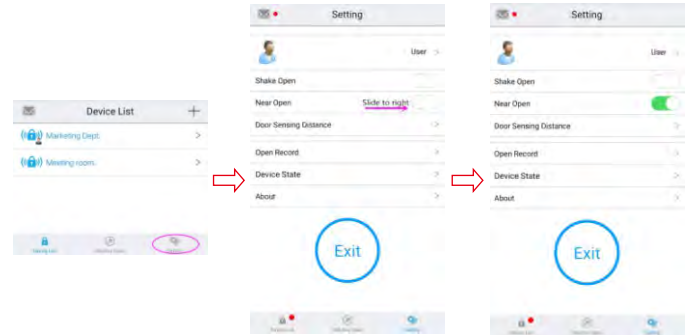

Note: After turning ON "Shake Open" / "Near Open", please set the appropriate door sensing distance you need.

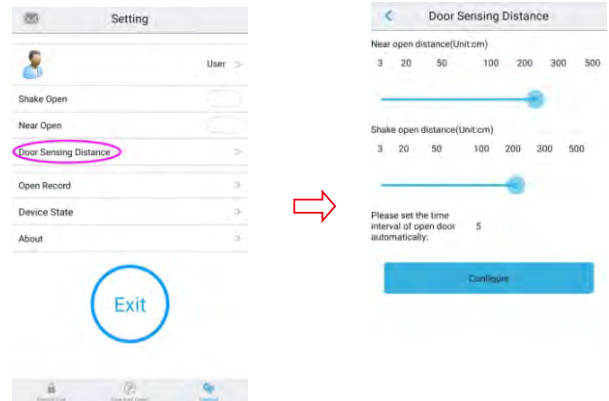

7. E-Key Manage

E-Key receivers can be set as Admin Master User or Common User, and the authority can be Forever or Limited.

(Remark: E-Key receivers must have registered in App firstly)



The E-Key receiver will see the device in the device list when login in

8. Delete E-Key

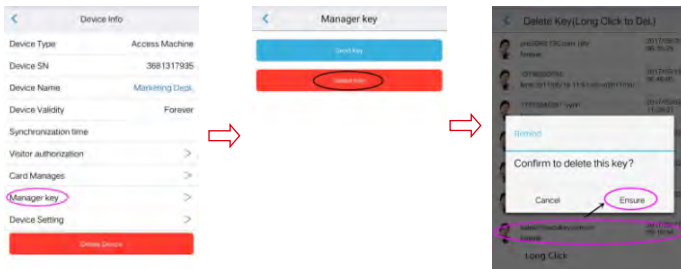

9. Modify Device Name

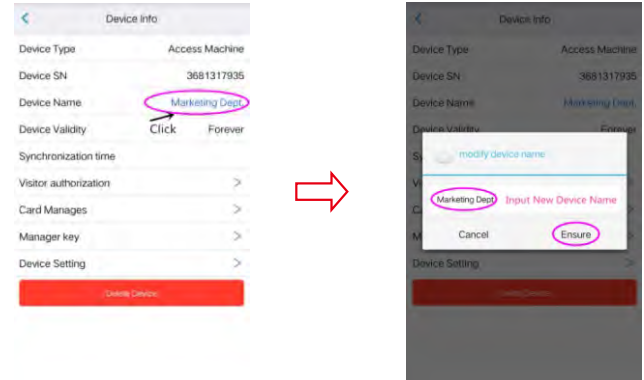

10. Modify Account Password

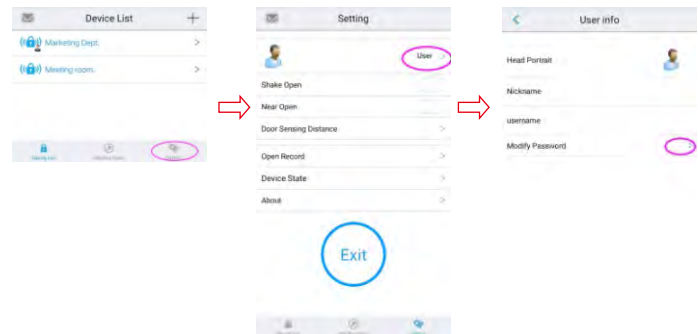

11. Device Reset (Method 1)

(Please refer to title OTHERS for Method 2)

Reset the device, the users' information is still retained.

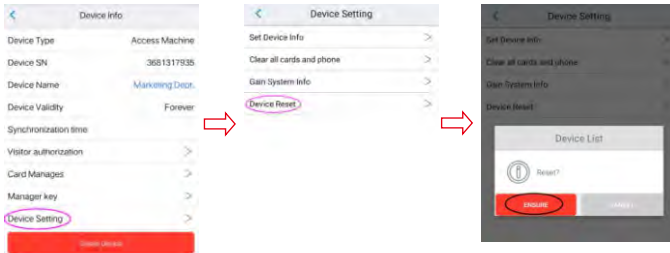

12. Erase ALL Users (Method 1)

(Please refer to title OTHERS for Method 2)

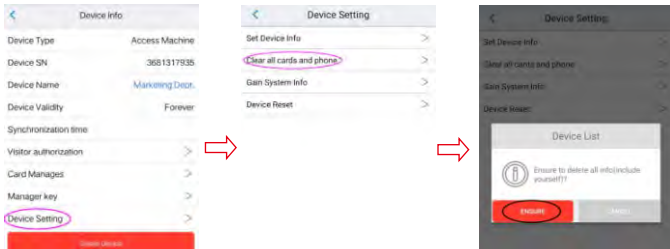

13. Delete Device

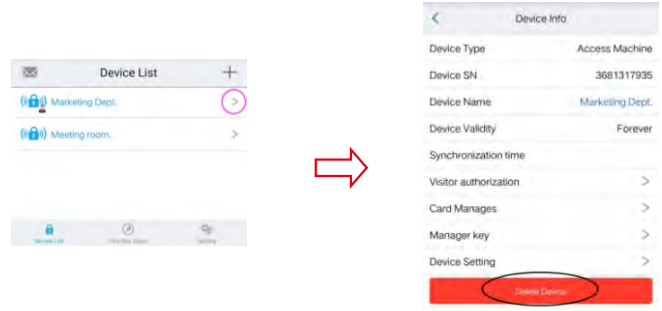

OTHERS

To Reset to Factory Default (Method 2)

To reset to factory default, power off and press exit button, hold it and power on (hold it for 10 seconds), release it until hear one beep and the LED in Red, means reset to default successfully.

Remarks: Reset to factory default, the users' information is still retained.

Erase ALL Users (Method 2)

After resetting to factory default, 1s later, press exit button, hold it for 10 seconds, release it until hear three beeps and the LED in a short Green then turns in Red, means clear data successfully.

Sound and Light Indication

Status	Light color	Buzzer
Standby	Red	-
Enter Programming	Red Shine Slowly	Beep-
Operation error and clear device	-	3 Beeps
Open lock	Green	Beep-